

MAGNUSON

SUPERCHARGERS

Installation Instructions for: CORVETTE MAGNUM DI SUPERCHARGER SYSTEM 2015+ LT4 Z06 CORVETTE



Step-by-step instructions for installing the best in supercharger systems.

*** PREMIUM GASOLINE FUEL REQUIRED ***

ATTENTION!

Your **MAGNUSON SUPERCHARGER** kit is sensitive to corrosion!

Use only the vehicle manufacturer recommended coolant for your engine in the intercooler system as well.



Magnuson Superchargers
1990 Knoll Drive, Bldg A, Ventura, CA 93003
(805) 642-8833
magnusonsuperchargers.com

INSTALLATION MANUAL

Magnuson Supercharger Magnum DI Kit GM 6.2 Liter Engine Chevrolet Corvette 2015+ LT4 Z06

Please take a few moments to review this manual thoroughly before you begin work. Make a quick parts check to be certain your kit is complete (see Bill of Material (BOM) parts list inside the accessory box). If you discover shipping damage or shortage, please call our office immediately. Take a look at exactly what you are going to need in terms of tools, time, and experience. Review our limited warranty with care. When unpacking the supercharger kit DO NOT lift the supercharger assembly by the black plastic bypass actuator. This is pre-set from the factory and can be altered if used as a lifting point!

Caution: Relieve the fuel system pressure before servicing fuel system components in order to reduce the risk of fire and personal injury. After relieving the system pressure, a small amount of fuel may be released when servicing the fuel lines or connections. In order to reduce the risk of personal injury, cover the regulator and fuel line fittings with a shop towel before disconnecting. This will catch any fuel that may leak out. Place the towel in an approved container when the job is complete.

Use only premium gasoline fuel, 91 octane or better.

Magnuson Superchargers recommend that you run a minimum of one (1) tank of premium fuel through your vehicle prior to installation of the system to prevent any possible damage that may occur due to running the supercharged engine on lower octane fuel.

Magnuson Superchargers systems are designed for engines and vehicles in “GOOD” mechanical condition. Magnuson Superchargers recommend that a basic engine system “Health Check” be performed prior to the installation of this supercharger system. Be sure to check for any pending or actual OBDII codes and fix/repair any of the stock systems/components causing these codes. If there are codes prior to the installation they will be there after the installation.

Magnuson Superchargers also recommends the following services to be performed on your vehicle before starting and running the vehicle post supercharger system installation:

- Fuel Filter change
- Engine oil and filter change using brand name oil (organic or synthetic) and filter
Note: It is VERY IMPORTANT to use the factory specified oil viscosity. The original equipment manufacturer has selected this grade of oil to work with your other engine systems such as hydraulic chain tensioners and variable cam controls. Deviation from this specification may cause these systems to fail or not function properly. Please refer to your owner’s manual for the recommended oil viscosity for your engine and application.
- On newer vehicles not requiring new spark plugs it is important to verify the spark plug air gap.

On older vehicles Magnuson Superchargers recommend these additional services to be performed:

- New spark plugs with the air gap set at the factory specifications OR new specifications if required by the installation manual.
- Coolant system pressure test and flush. **NOTE: YOU MUST USE GM SPECIFIED COOLANT MIXTURE.**

Non “Magnuson Approved” calibrations or “tuning” will Void ALL warranties and CARB certification.

Tools Required

Metric wrench set

1/4" - 3/8" and 1/2" drive metric socket set (standard & deep)

3/8" and 1/2" drive ft-lbs and in-lbs torque wrenches

Phillips and flat head screwdrivers

1/2" breaker bar

Serpentine belt wrench

Fuel line quick disconnect tools (included in kit)

Funnel

Hose cutters

Hose clamp pliers

Safety glasses

Hammer

Nut driver

Compressed air

Heat gun

Metric Allen socket set 3/8 drive

Metric Allen wrenches

Torx socket set 3/8 drive

Plastic pry bar

Oetiker clamp pliers

Rotary Cutting Tool or Hacksaw

Band Saw

Contact Information:

Magnuson Superchargers

1990 Knoll Drive, Bldg A

Ventura, CA 93003

Sales/Technical Support Line (805) 642-8833

Website www.magnusonsuperchargers.com

Emails sales@magnusonsuperchargers.com

support@magnusonsuperchargers.com

Table of Contents

Section 1:	Tuning your Vehicle Computer and Initial Steps	5
Section 2:	Removal of Factory Supercharger and Accessories	6
Section 3:	Fuel Line Removal and Rerouting	13
Section 4:	Preparing the Supercharger and Installation	21
Section 5:	EVAP Solenoid, Brake Booster, and Coolant Line Installation	30
Section 6:	Hose Line and Lid Installation	36
Section 7:	EVAP, Throttle Body and Belt Installation	38
Section 8:	Coolant Fill and Final Testing	41
Appendix		43

NOTE TO CUSTOMERS WITH MODIFIED VEHICLES:

The Magnuson calibration included with this kit is intended to work on stock vehicle configurations, including stock trim levels and stock OEM vehicle options. Modifications to your stock vehicle including, but not limited to, engine, flywheel, clutch, torque converter, transmission, wheels, tires, axles, gears, driveshafts, induction system, exhaust system and additional weight (ie. bumpers, racks, etc.) can have a significant impact on your vehicle's calibration and may require modifications to our calibration as supplied.

While we attempt to minimize the need for modifications during our development process, it is impossible for our team to account for all possible build variations/combinations, and in some cases it may be necessary for you to supply an additional element of customization for your vehicle—custom calibration—and to work, at your own direction and expense, with a local service facility to address your unique combination of hardware and make calibration adjustments as necessary.

Please be aware that standard product warranties and governmental emissions certifications are predicated on stock vehicle configurations, and vehicle modifications and calibration changes may affect or even void powertrain warranty and emissions certification status (such as CARB emissions certification). It is the sole responsibility of the customer making a warranty claim to prove that any vehicle modifications and calibration changes were within warranty. It also is the sole responsibility of the customer to determine if the modifications and changes comply with all local, state and federal emissions standards.

Section 1: Tuning your Vehicle Computer and Initial Steps

Any reference to left or right side of vehicle is given from driver's seat perspective.

1. If your kit has a provided handheld tuner follow the instructions in the provided pamphlet to install your tune. Your handheld tuner may not match the one shown.
2. Your Intercooler system is sensitive to corrosion. It's very important to use the OEM recommended coolant mixture in your supercharger system as well.
3. Your system requires the use of minimum 91 Octane gasoline fuel. This system is **not** compatible with E85 fuel.
4. Remove the negative cable from the battery with a 10mm wrench. The battery is located in the right rear of the cargo compartment under the carpet. Place a rag over the negative terminal to prevent accidental connection. Place a rag over the rear hatch latch to prevent locking.



Section 2: Removal of Factory Supercharger and Accessories

5. Disconnect the PCV line from the intake duct. You will have to press the gray button (shown with the arrow) on the connector to release it.



6. Loosen the two hose clamps for the intake duct using an 8mm nut driver or standard screwdriver.

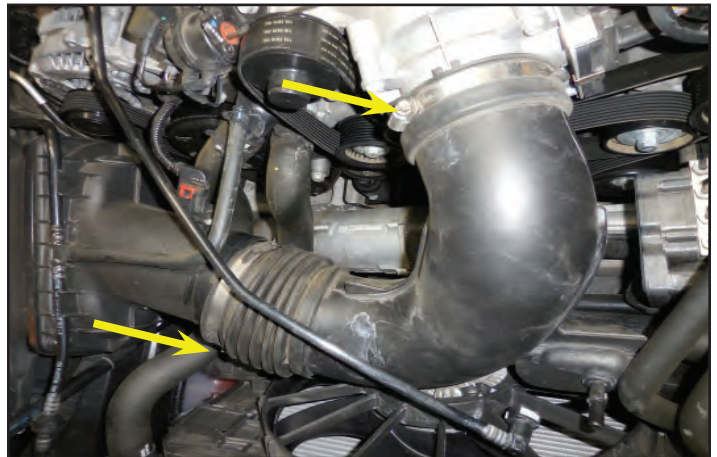

7. Remove the intake duct from the throttle body and the air filter box. This will be reused.



8. Remove the supercharger belt by rotating the tensioner shown with the arrow in a counter-clockwise direction using a short 15mm socket and a serpentine belt wrench. This belt will not be reused.



9. Here you can see the serpentine belt wrench attached to the tensioner. Rotate it counterclockwise to release the belt tension and pull the belt off the pulleys. The belt will not be reused.

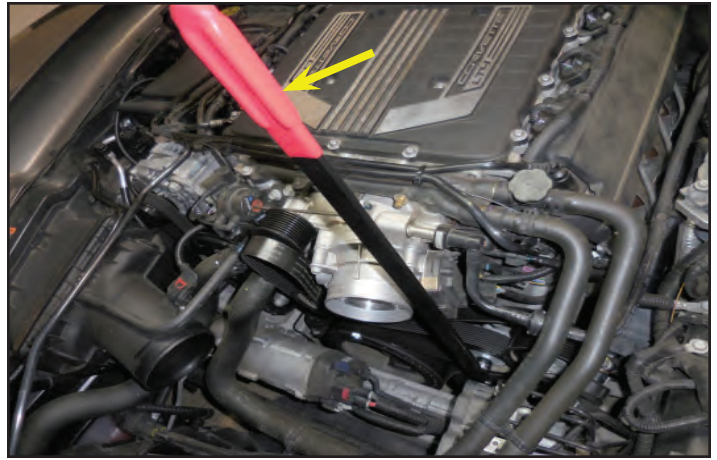

10. Use hose pinch off pliers to restrict the flow of coolant on the two intercooler hoses shown.



11. Now remove the clips retaining the hoses in the location shown with the arrows. You can use a small screwdriver or pick to pull the clips out. Place a rag under the connections to catch any coolant.



12. Here is one of the clips removed in the last step.



13. Disconnect the two intercooler hoses at the locations where the retainer clips were removed.

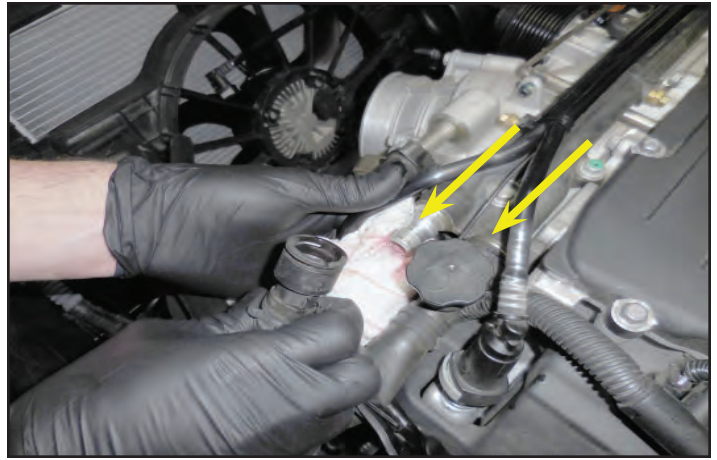

14. Once you have the hoses disconnected you can cap the two ends where shown.



15. Disconnect the two EVAP and PCV plugs shown.

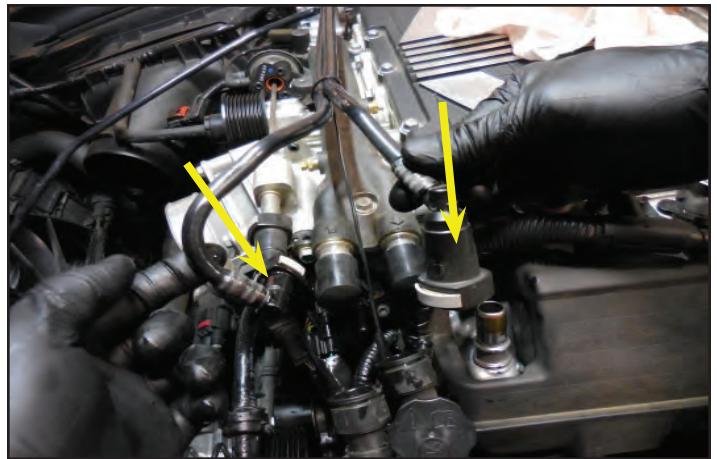

16. Disconnect the electrical plug from the EVAP solenoid by first pulling on the white locking tab and then you can unplug the connection.

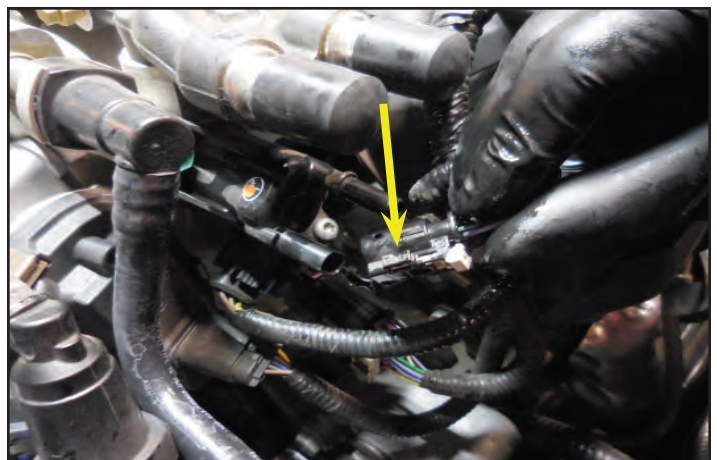

17. Disconnect the EVAP and PCV connections shown with arrows.



18. Also disconnect the PCV line shown. Remove all the EVAP and PCV lines that were just disconnected from the vehicle.



19. Unplug the Electronic Throttle Control (ETC) connector where shown. First you will have to release the red tab by pulling it out. Then press the lever on top while pulling out on the connector.



20. Disconnect the electrical connection for the front MAP sensor shown with the yellow arrow. For the MAP sensor you will have to pull on the blue tab, and then press on the black lever while pulling out on the connector. Remove the bolt holding the EVAP solenoid shown with a green arrow, and set aside the EVAP solenoid for later installation. Remove the Torx bolt shown with the red arrow and remove the front MAP sensor. Set the front MAP sensor aside for installation to a new assembly later.

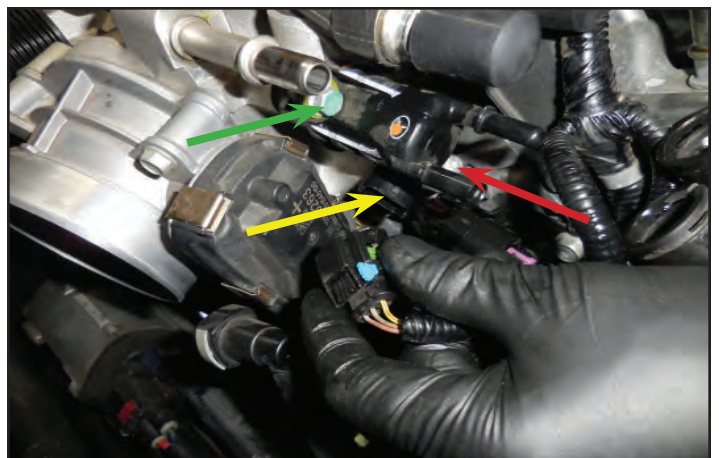

21. Remove the 4 bolts shown with arrows using a 10 mm wrench.

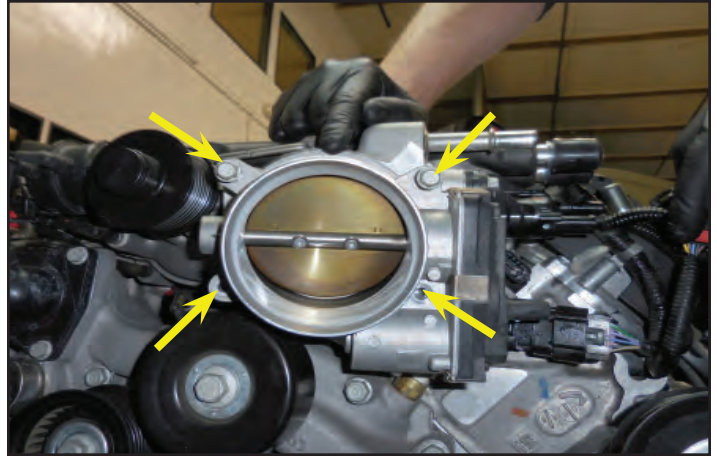

22. Remove the throttle body from the vehicle.



23. Vacuum out across the supercharger lid. Remove all debris from the counterbores shown with arrows.

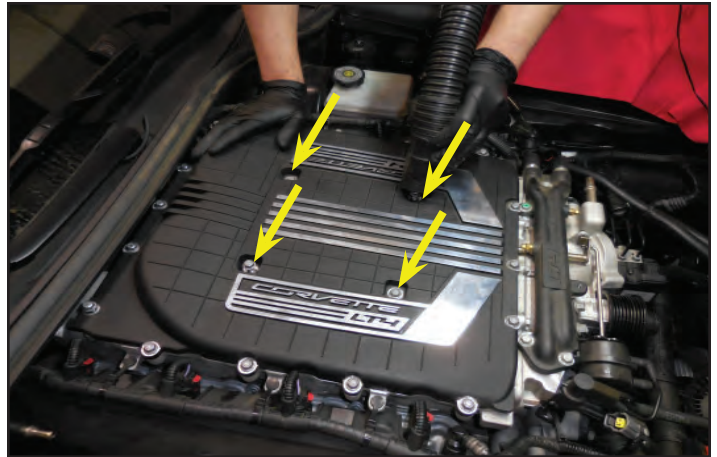

24. Remove all 20 bolts holding the lid in place. Then remove the lid.

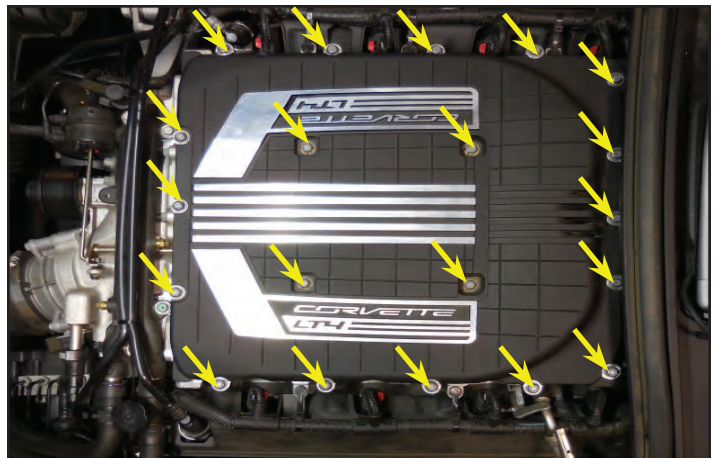

25. Remove the 10 bolts shown with arrows holding the supercharger housing in place.

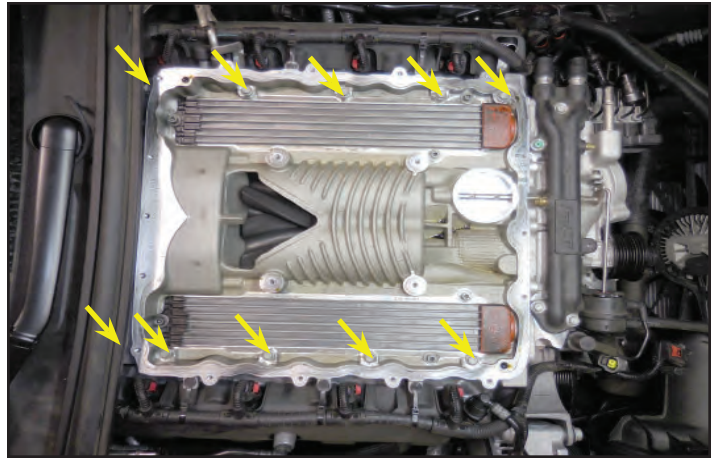

26. Two of the bolts from the last step are hidden below the cowl. This is on the right rear of the supercharger.



27. Here is the other hidden bolt on the left rear of the supercharger.

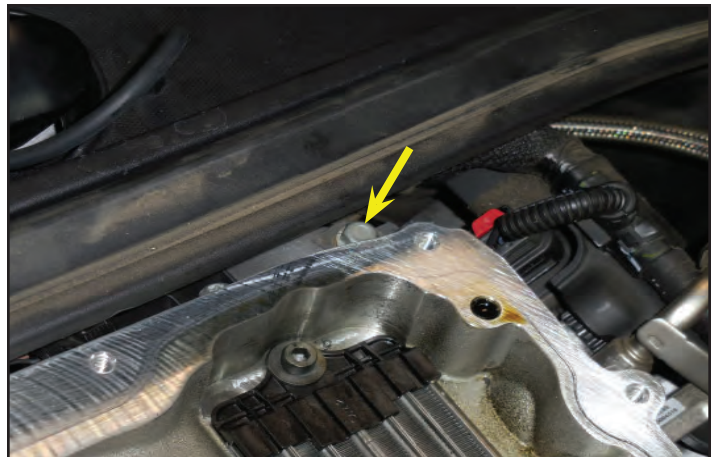

28. Use a plastic pry bar to remove 5 wire tie anchors on both sides of the supercharger housing.



29. Remove the wire tie anchor shown with the yellow arrow. Disconnect the plug shown with the green arrow. Also disconnect the two hoses shown with red arrows. Use a 10mm socket wrench to remove the bolt holding the solenoid bracket at the blue arrow location. This solenoid and bracket will be reinstalled later.

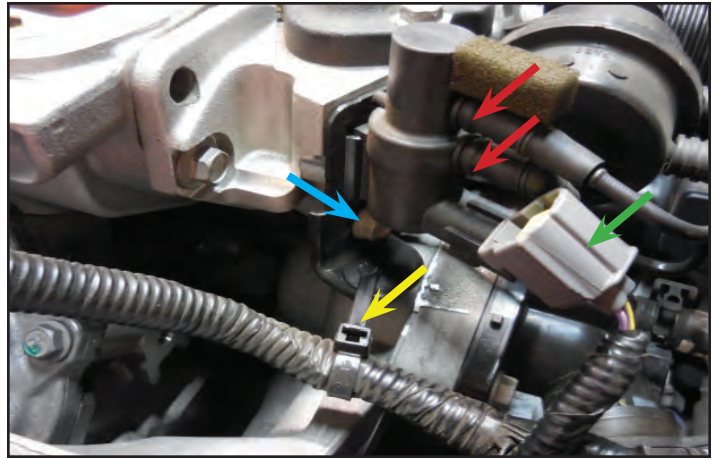

30. Pull the red safety clip and unplug the MAP sensor at the rear of the supercharger.

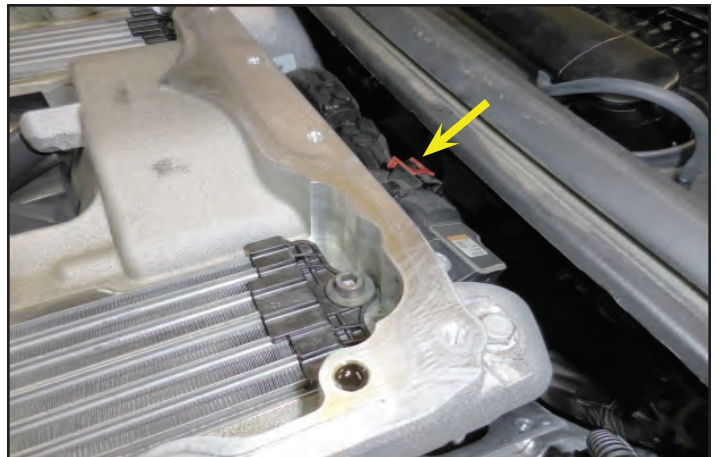

31. At this point you will need some help to remove the supercharger from the engine. Have at least one other person on the opposite side of the engine bay while you lift it up, then pass it off to the other person. Carefully clean up the surface around the intake ports. Use isopropyl alcohol to clean the surface around the ports. **Make sure nothing enters the intake ports.**

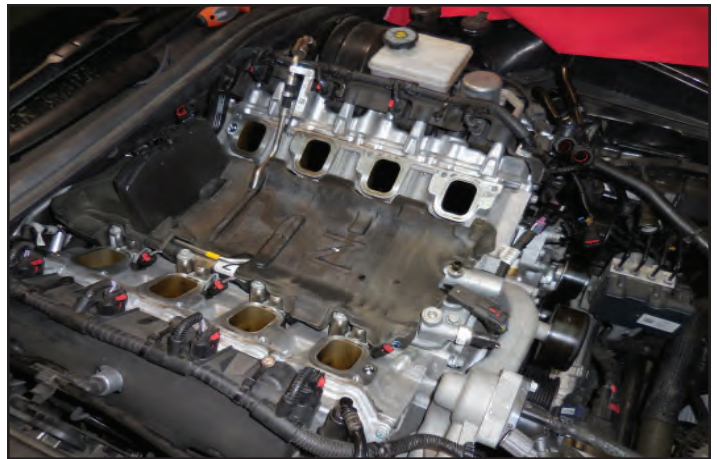

32. Clean and Inspect the PCV fitting shown with the arrow to ensure it isn't damaged.



33. Apply blue tape over the ports to prevent anything from entering the engine. Remove the insulation from the manifold valley shown with an arrow. This insulation will not be reused.

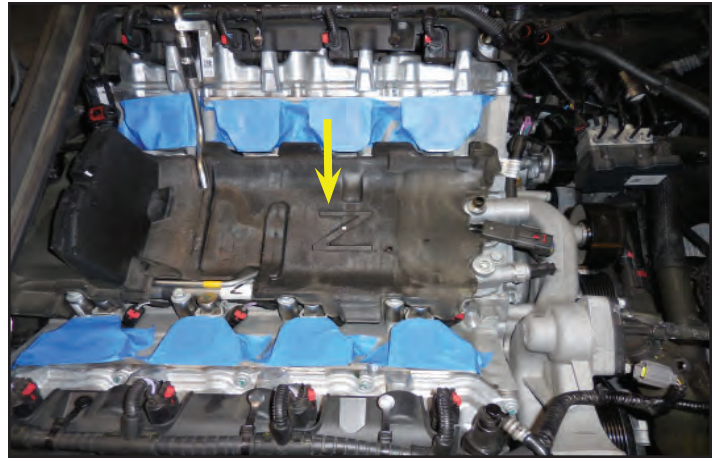

34. Vacuum out the manifold valley to remove any debris.

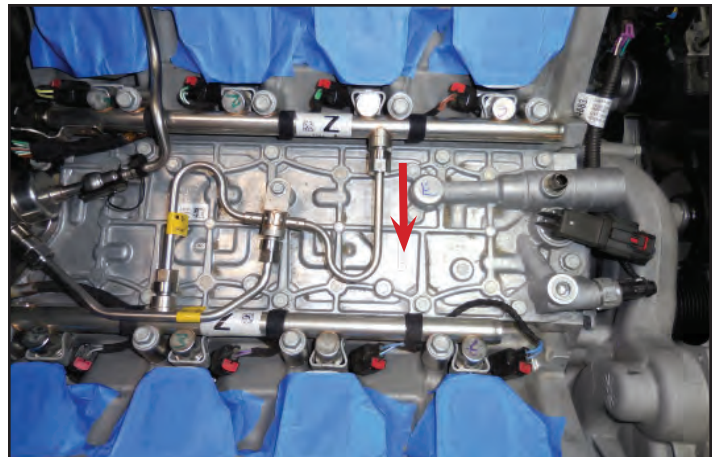

Section 3: Fuel Line Removal and Rerouting

35. Remove the fuel line safety clip by prying up at the side shown with the red arrow first, and then sliding off in the direction of the green arrow.



36. **Eye protection is necessary.** Place the provided plastic tool over the fuel line at the green arrow location shown. Place rags under the fuel line connection. Push the fuel supply line in towards the engine. Now pull the plastic tool towards the fuel supply line. This will disengage the fuel line connection allowing you to pull the line off. This will release the connection. Be careful while releasing the connection because fuel will spill. Properly dispose of any fuel soaked rags after the fuel line is removed.



37. Remove the bolt at the green arrow location with a 10mm wrench.

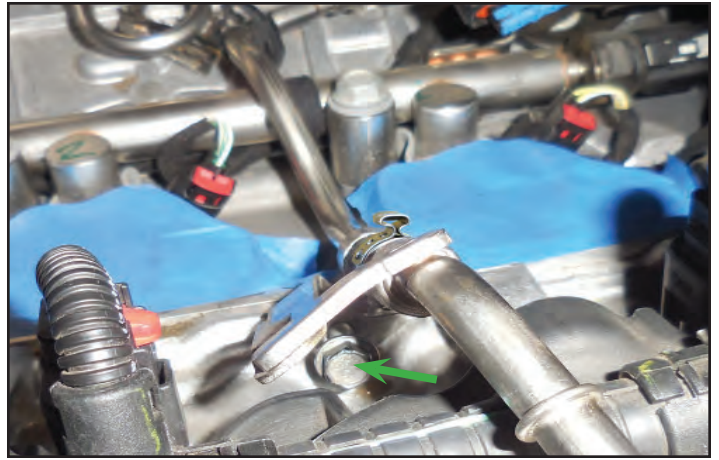

38. Place rags in the manifold valley under the fuel line. Repeat the process of removing the safety clip and disconnect the fuel line using the provided plastic fuel line tool. Remove this fuel line. It will be replaced with a provided fuel line in the next step.



39. Gather the provided fuel line.



40. Leave the black plastic release insert on the end of the provided fuel line. This can be used to remove the fuel line in the future if needed.



41. Install the provided fuel line by routing it in the location shown highlighted in green. **Ensure that you slide the hose under the hardline shown with the red arrow.** Place two provided Adel clamps in the yellow arrow locations to secure the hose. The clamps should not crush the hose. The end connections will be shown in the following steps.

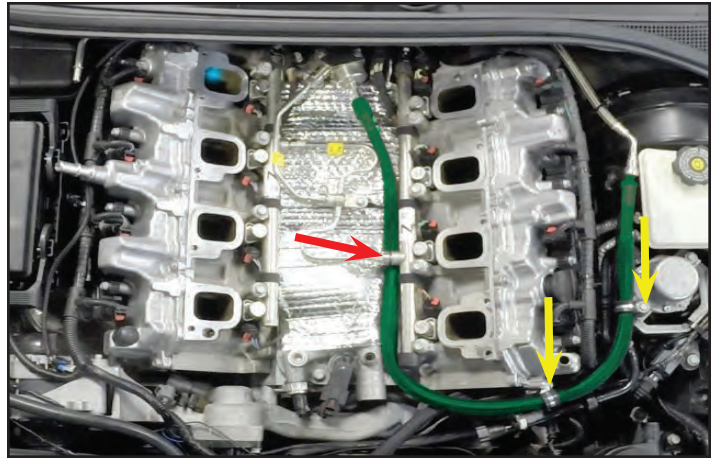

42. Connect the female fuel line connector at the OEM location in the engine valley. **Ensure that you hear a click which indicates that the connection is secure. Pull at the connection to verify it is secure.**



43. Connect the male fuel line connector to the female connector on the supply line. **Ensure that you hear a click which indicates that the connection is secure. Pull at the connection to verify it is secure.**



44. Install the OEM clip to the fuel connection from the last step and secure with the OEM plastic tether.

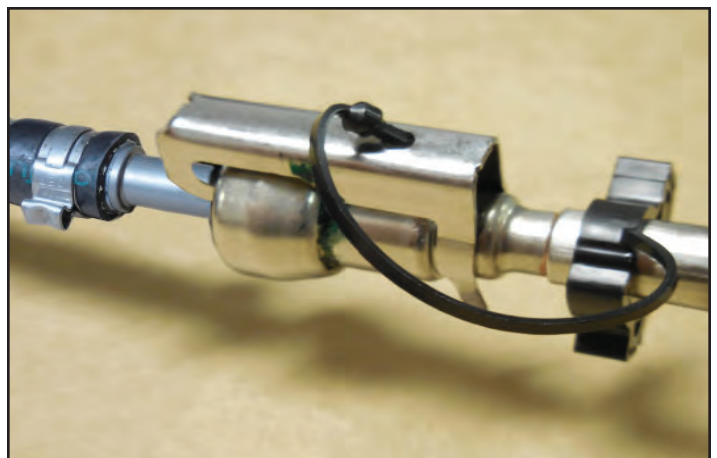

45. Loosen the T30 Torx fasteners (2 each) at the coil covers.



46. Remove the plastic coil cover. Repeat on the opposite side.



47. Disconnect the spark plug wires from all the coils. Disconnect the electrical connector on top of the coils. Remove the two screws securing the coils using a 10 mm socket. Set the coils aside for reinstallation later.



48. Once you have removed all the coil packs you can remove the valve covers. These will be modified in the next steps.



49. Remove the gaskets from the two valve covers.

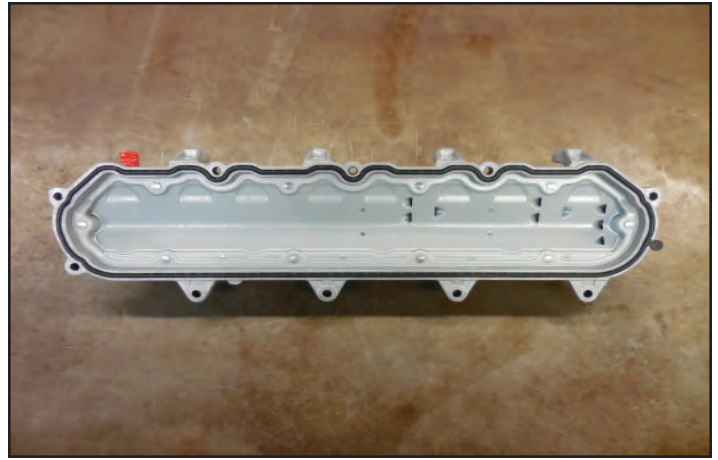

50. There is a tab at the corner that allows you to easily pull this gasket out.



51. Apply masking tape to all the inlets of the valve covers prior to cutting.

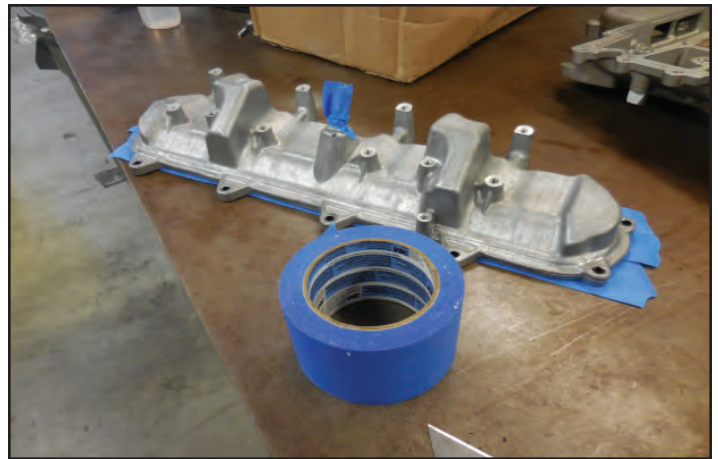

52. Tape the bottom surface as well.

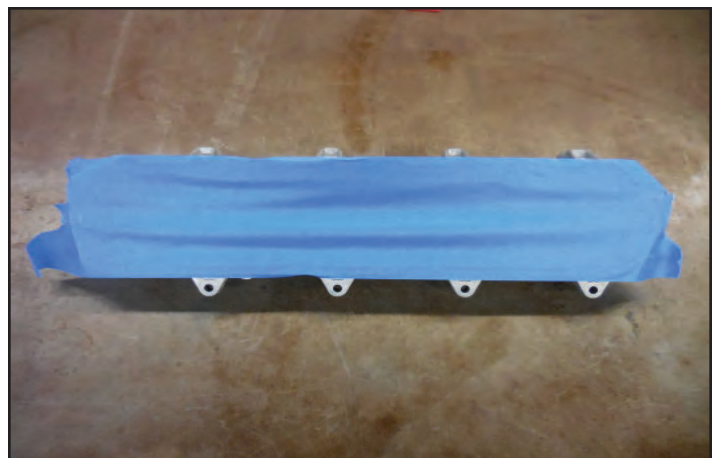

53. Gather the supplied wedges for trimming your valve covers.



54. Place the wedges on the bottom using the bolt holes to secure them in place.

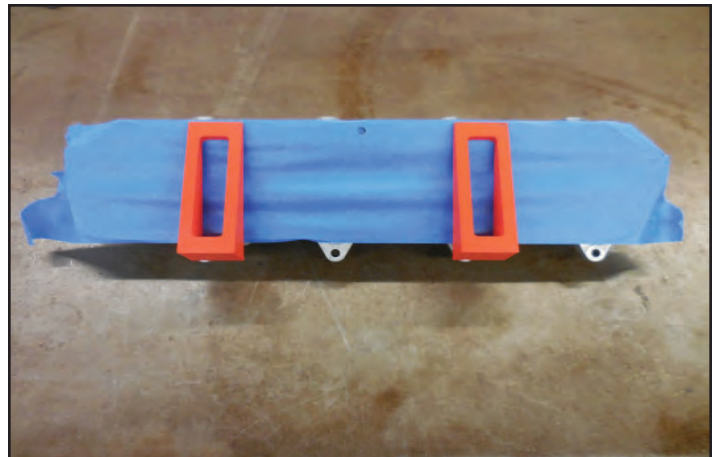

55. Ensure that the wedges sit flat against the bottom of the valve covers, and that they contact the band saw table and guide fence as shown here.

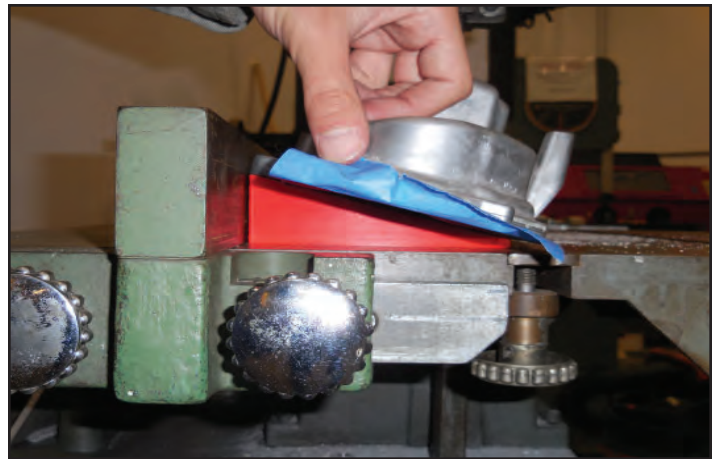

56. Cut each of the top coil pack mounts flush with the valve cover. You will have to stop the saw to reposition the wedges for each cut.

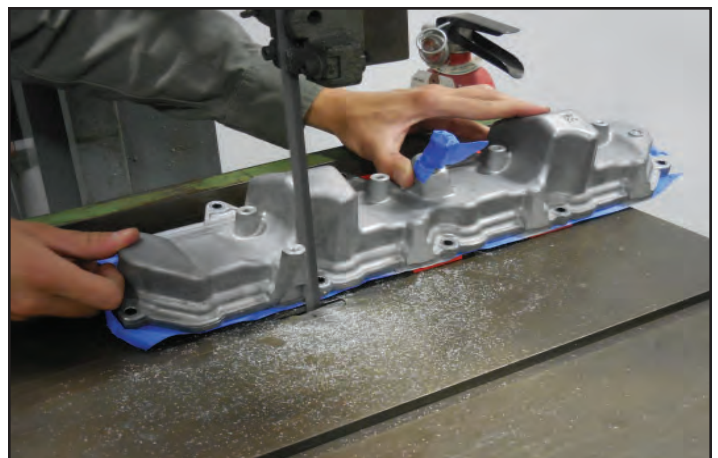

57. Once you have cut the upper coil pack mounts flush you will need to remove any sharp edges. Also thoroughly clean all the debris from the covers once you have removed the sharp edges.

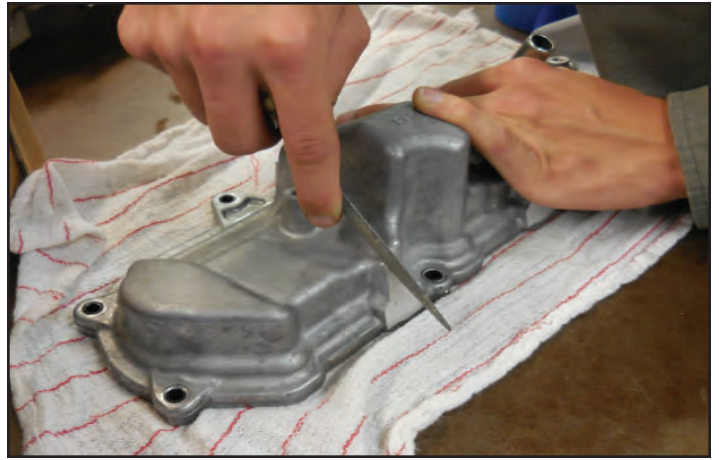

58. Mark the air tube on the passenger side valve cover just past the flare shown at the dashed line location.

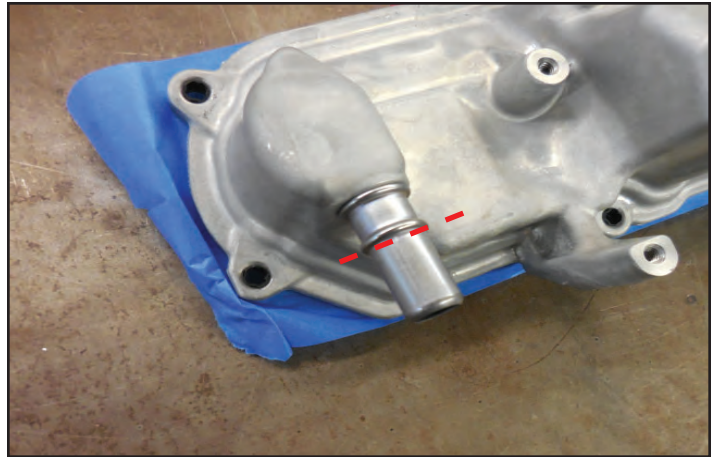

59. Use a rotary cutting tool, or hacksaw to cut this airtube past the flare as shown.



60. Here is a photo of the shortened air tube. Debur the cut edge, and remove the masking tape. **Clean out the debris using a solvent cleaning tank. Ensure that the cover is thoroughly clean and dry before installing them on the heads.**



61. Re-install the gaskets on both valve covers.

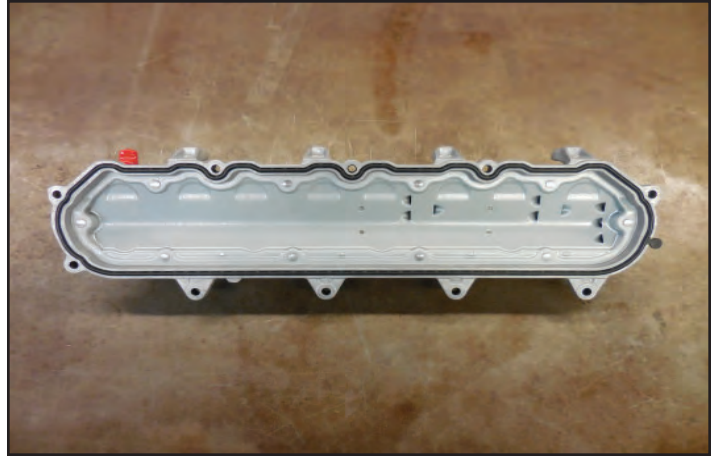

62. Gather the following bracket, nuts and spacers. You will need one set per side.

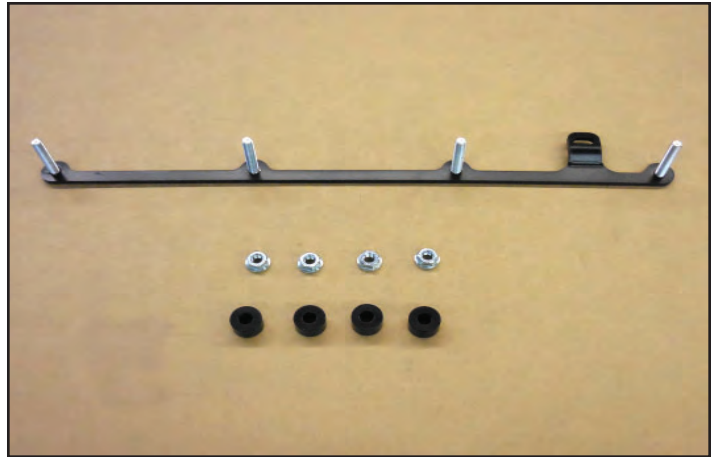

63. Install the spacers on the studs as shown.

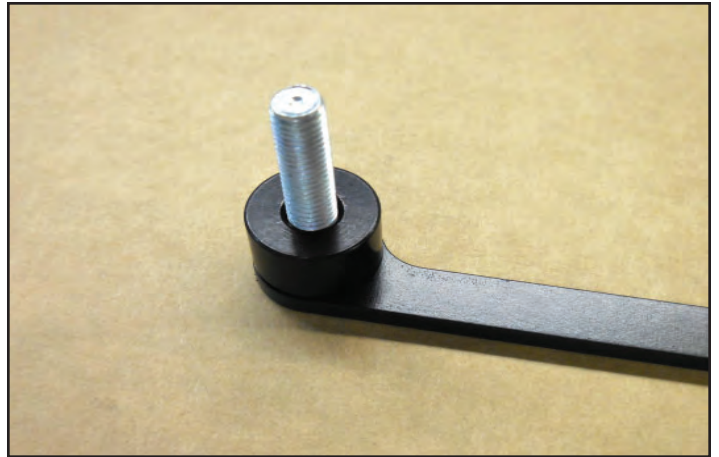

64. Install the coil covers with the supplied lower mount as shown using the provided nuts.

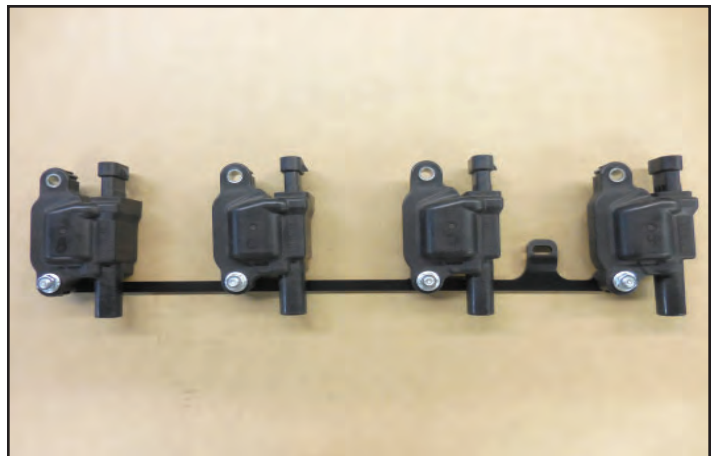

65. Use the OEM bolts at the red arrow locations to install the coils back on the valve covers that were just modified. This will shift the coil packs lower in the engine to give clearance for the supercharger. Install the provided M6x14mm bolt at the yellow arrow location. Repeat this process on the other valve cover.

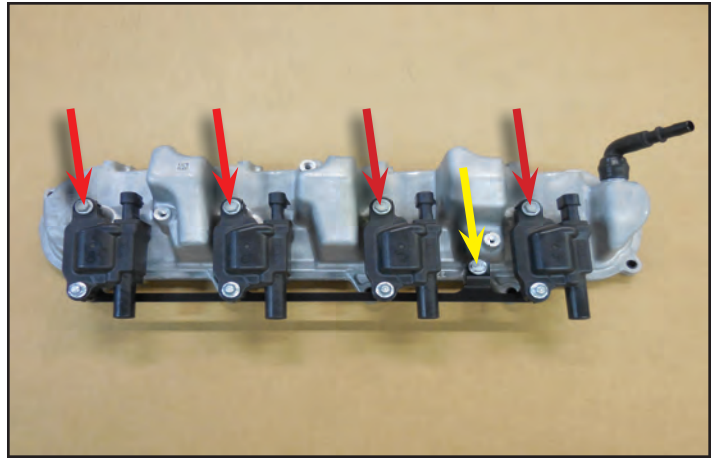

66. Reinstall the valve covers and carefully route the wires out of the way as shown here.



Section 4: **Preparing the Supercharger and Installation**

67. Remove the MAP sensor from the back of the OEM supercharger.



68. Remove the bolt from the location shown here on the new supercharger. This is where the MAP sensor from the previous step will be installed. Apply a light coat of supplied Lubriplate grease to the bore shown with an arrow.

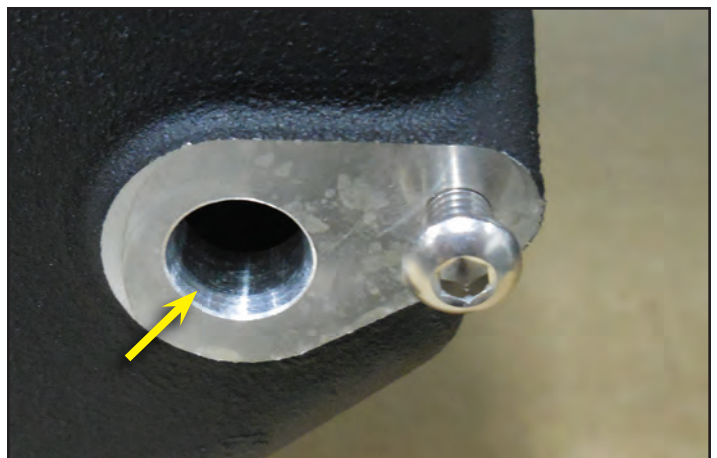

69. **Apply Loctite 242** to the end of the bolt removed in the last step.



70. Apply a light coat of Lubriplate grease to the O-ring on the MAP sensor and carefully press it into place. Install the bolt from the last step and tighten in place.



71. Apply some supplied Lubriplate grease to the PCV seal at the bottom of the Magnuson supercharger.

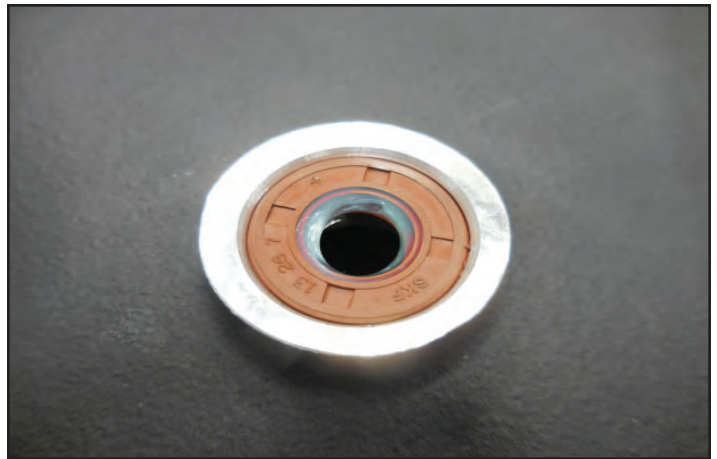

72. Remove the 19 M6x30mm bolts around the perimeter of the lid and remove the lid. Also remove the four screws holding the Magnuson Supercharger Emblems to gain access to the 4 bolt locations that will be fitted with M6x30mm bolts later.



73. Remove the 3 bolts holding the coolant manifold assembly at the front of the supercharger and pull the spigot out. Repeat this process on the other coolant manifold assembly.

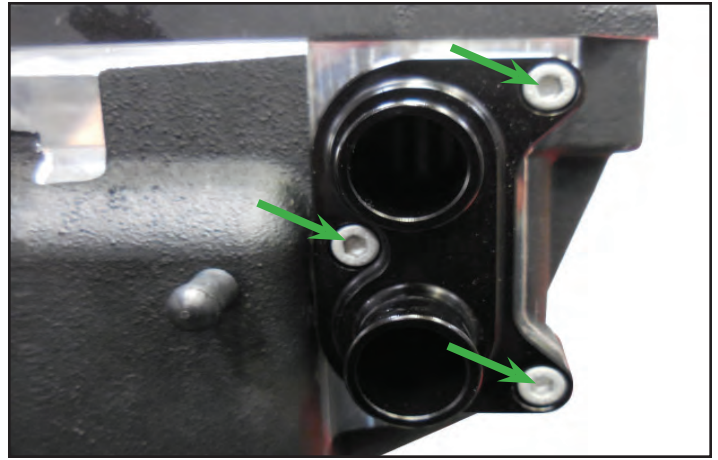

74. Remove the 6 bolts holding the charge air coolers inside the supercharger housing and pull the charge air coolers out. Carefully pull out the charge air coolers by hand. Pull evenly around the perimeter to disengage the seal.



75. Gather the MAP/IAT breakout harness.



76. Pre-install the IAT sensor wire to the supercharger prior to installation. Be careful with the wire assembly while you are installing the supercharger.

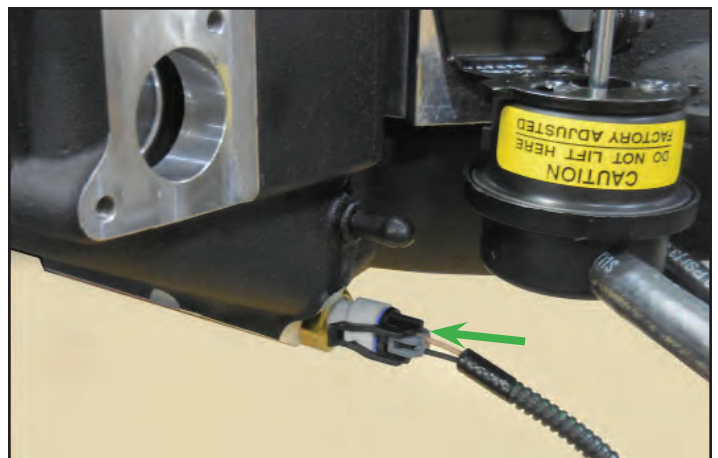

77. Remove the blue tape from the intake ports.

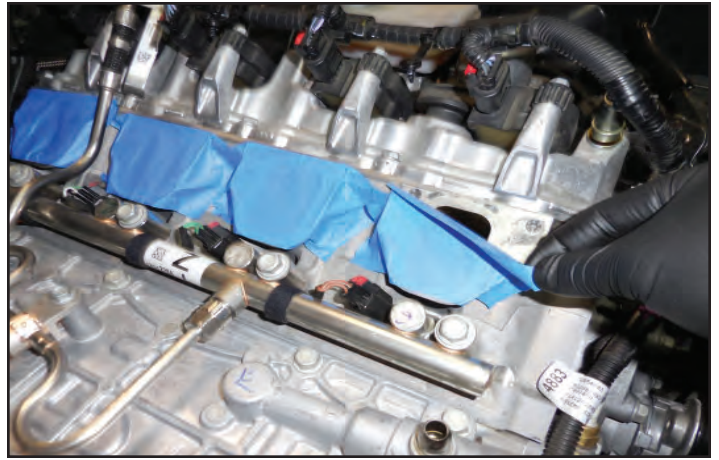

78. Wipe down the intake port outer sealing surfaces with a rag coated with Tri-flow. Pull the coil harnesses to the sides to make clearance for supercharger installation. Ensure that there are no tools or other items left in the valley area before you install the supercharger.

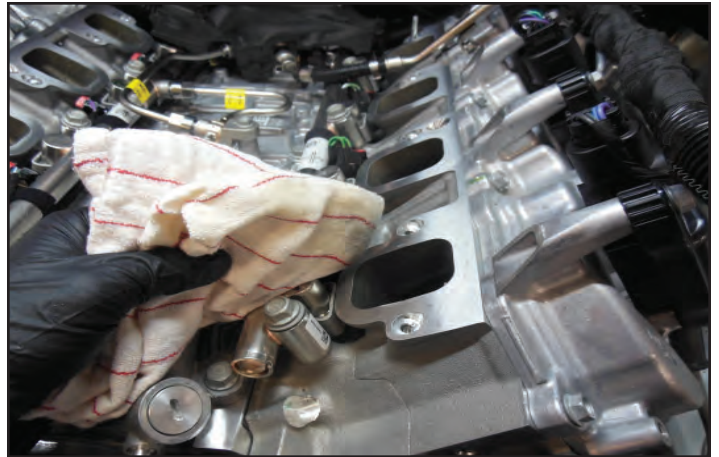

79. Have someone help you support the supercharger from the opposite side while installing. Carefully place the supercharger on the inlets for the heads. Leave enough space at the back to allow the installation of the rear MAP sensor connection.

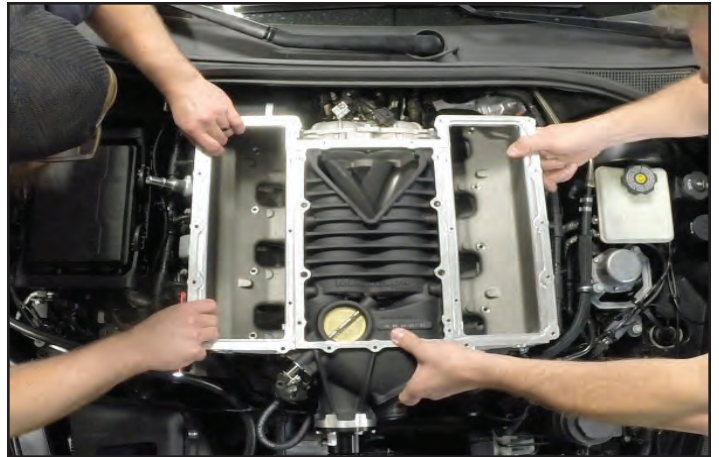

80. Plug in the MAP/IAT breakout wire assembly into the rear MAP sensor shown here at the arrow location.



81. Plug in the other end of the MAP/IAT breakout wire assembly to the wire that led to the OEM rear MAP sensor. After you have plugged in the MAP sensor you can slide the supercharger assembly back so the intake ports line up.



82. Install the provided seal washers shown with a blue arrow on 10 provided M6x30mm flange bolts. Once you have slid the washers on all the way to the heads apply a light coat of Lubriplate grease to their undersides. Finally **apply blue Loctite 242** to the ends of these bolts as shown.



83. **Ensure that the supercharger is sitting flush with the intake ports prior to installing the bolts.** Place the ten M6x30mm bolts from last step with washers installed into the ten locations shown here with arrows. Thread them into these locations carefully by hand at first. **Following the torque order given at the back of this manual making 3 passes, slightly increasing torque each time until you make the final pass at 106 in-lbs.**

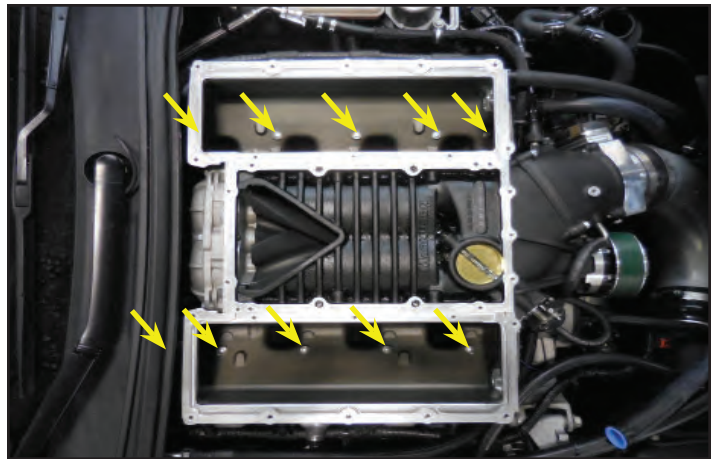

84. **Ensure that the supercharger pulley still spins freely after full torque is applied.**

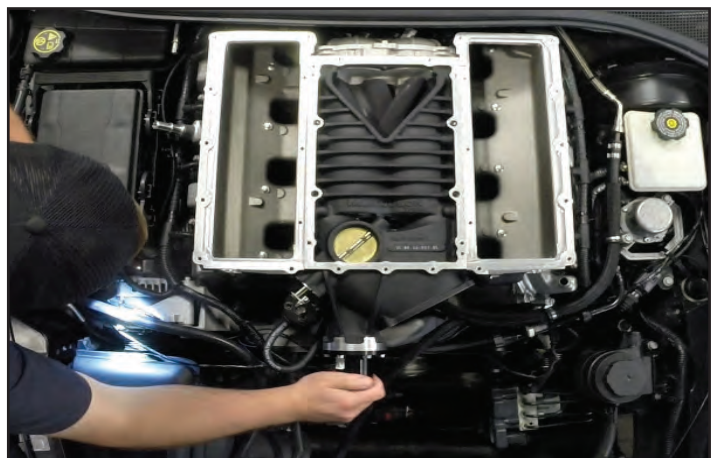

85. Reinstall the charge air coolers (2 each).
Ensure that the port holes match with holes in the housing.



86. Locate the six M5x12mm button head bolts that held the charge air coolers in place. **Apply the provided Loctite 242** on the ends of each bolt.



87. Install the six M5x12mm button head bolts from the last step to secure the charge air coolers in the locations where they were originally.



88. Gather the coolant manifolds shown that were removed earlier. **Relube all the O-rings with the provided Lubriplate grease prior to reinstalling the coolant manifolds.**



89. **Apply Loctite 242** to the six M5x16mm socket head bolts coolant manifold bolts that were removed earlier.



90. Carefully install the coolant manifolds, taking care not to damage the O-rings, with the six M5x16mm socket head bolts from the last step. After you have tightened these six bolts go back and tighten the 6 bolts holding the charge air coolers.



91. Gather the following provided 38" hose with mesh over it, shrink tube, 17mm Oetiker clamp, and fittings. Follow the instructions in the next step for assembly of this EVAP hose.



92. Ensure that the 90° fitting has the white release button. After this you will slide the heat shrink tubing half way over each end of the mesh and the other half over the hose to protect the mesh from fraying. Use a heat gun to shrink the tubing over the ends of the mesh. Slide the 17mm Oetiker clamp over the side where you will put the straight connector. Press the barbed ends of the straight and 90° fitting into the ends of the hose until they bottom out. You may need to heat the hose a little to get the 90° fitting on. Use Oetiker clamp pliers to secure the clamp.



93. **(Note: several of the photos in the next few steps show our TVS2300 kit but the routing is similar)**

Install the hose assembly from the last step in the location shown highlighted in green. The side with the 90° will go under the bracket in the arrow location. The other end of the hose will route around the right side of the supercharger.



94. The hose assembly from the last step will continue to route over the right valve cover and will connect to the fitting shown with the arrow.



95. **Apply Loctite 242** to the provided three M6x25mm bolts and both sides of the provided stud.



96. Prior to installing the throttle body adaptor make sure that the O-ring is installed in the supercharger housing and throttle body adaptor. Install the stud and nut from the last step at the green arrow location. Ensure that the stud is protruding enough for the nut to have full thread engagement. Install the three M6x25mm bolts from the last step to the throttle body adaptor in the red arrow locations shown (the dashed arrow shows the bolt that is hidden from view) and **torque to 106in-lbs.**



97. Gather the following supplied front MAP sensor bracket assembly and 5/16" diameter hose. Gather the 19.5" of the provided 5/16" hose and press it on the brass barb. This assembly will allow you to reroute the front MAP sensor into a new location. Remove the MAP sensor from the front of the OEM supercharger and install it to the adaptor using the OEM bolt in the location shown with an arrow.

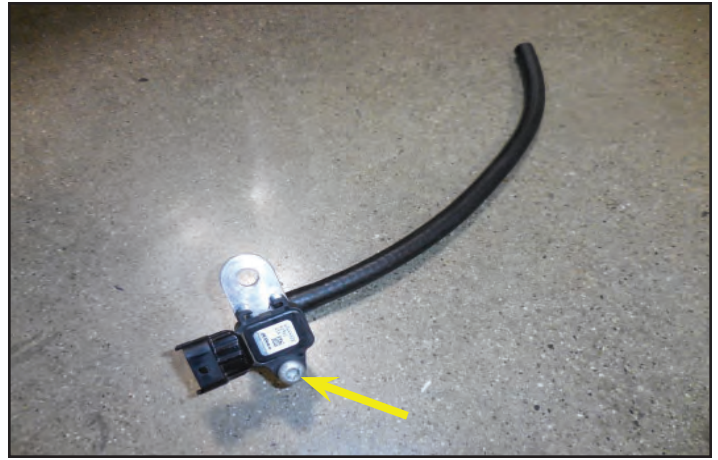

98. Install the supplied M8x45mm bolt and spacer shown to the front MAP sensor mounting bracket assembly from the last step.



99. Remove the bolt from the location shown with the arrow but do not remove the bracket it is holding. This will be secured with the new assembly in the next step.



100. Install the provided hose assembly with the bolt and spacer from two steps ago into the location where the bolt was removed in the last step. Make sure that it holds the OEM bracket in its original location.



101. Here is the final location of the MAP sensor mounting bracket. Run the hose up and under the Throttle Body Adaptor.

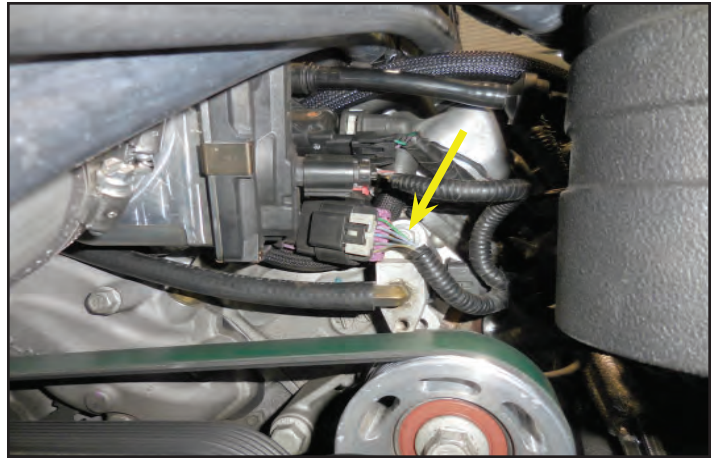

102. Install the opposite end of the hose from the last step to the air tube shown with the arrow. Ensure that the hose does not interfere with the belt line.

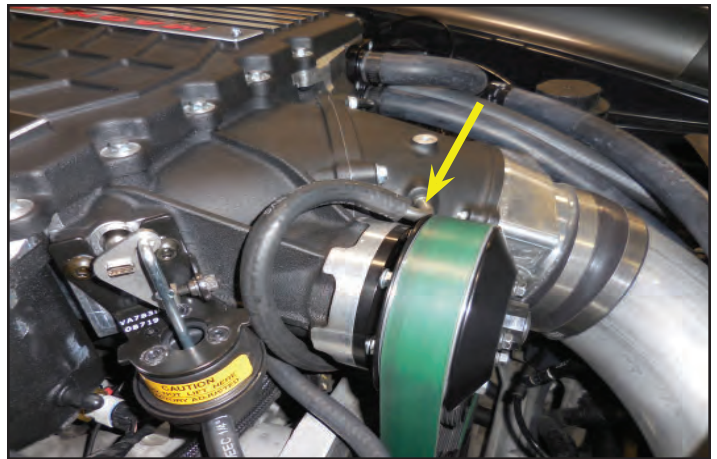

Section 5: **EVAP Solenoid, Brake Booster, and Coolant Line Installation**

103. Reinstall the EVAP hose and the electrical connection to the EVAP solenoid.

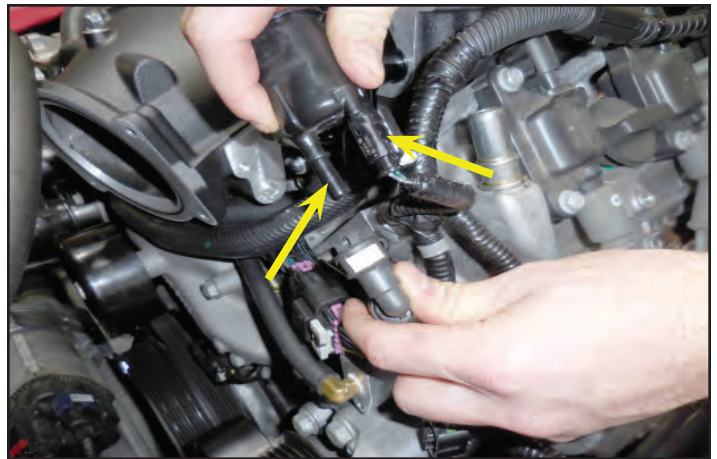

104. Place the EVAP solenoid in the location shown with the yellow arrow.

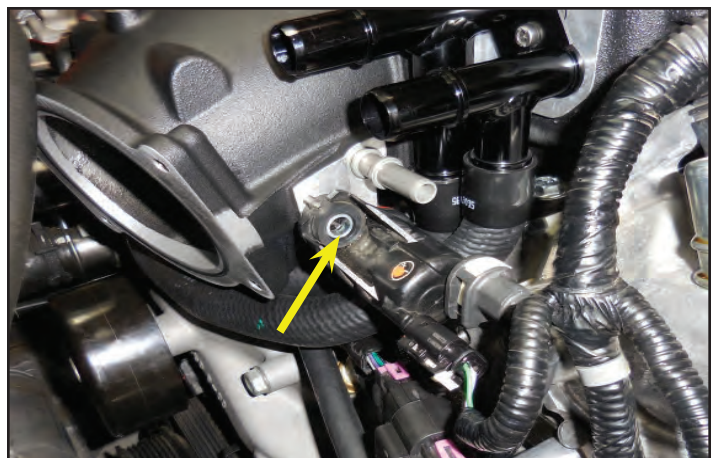

105. Use the original bolt to secure the EVAP solenoid, and **torque it in place to 106 in-lbs.**



106. Disconnect the electrical connection shown from the brake booster hose. Pull the check valve from the brake booster housing.



107. Disconnect the connection shown with the arrow. Remove the brake booster hose assembly. This will be replaced by a provided assembly in the next steps.

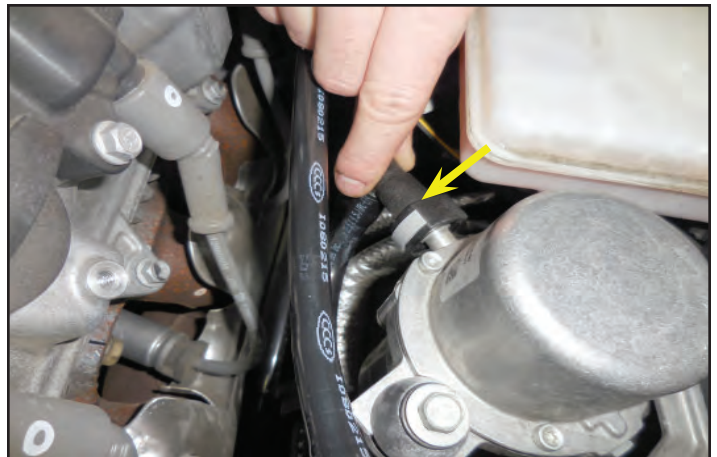

108. Here is the brake booster hose assembly that was just removed. Remove the hose section highlighted in green at the location shown with the red arrow.

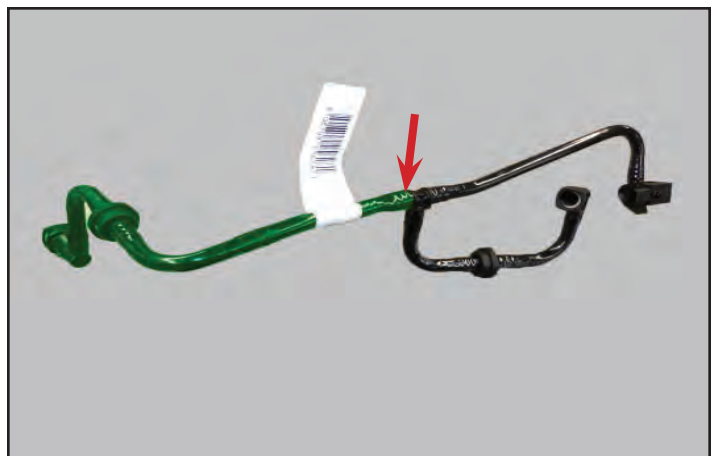

109. You may have to lightly cut through the hose to remove it. Be careful not to cut past the tube since this may compromise the connection of the new hose.



110. Gather the following provided parts. The hose is 8.5" long x 11/32" ID. The mesh is 10" long x 1/2" diameter. At the bottom is a check valve.



111. Cut a 2" piece of hose from the 11/32" hose.



112. Cut 2.5" of the mesh.



113. Look for the arrow on the check valve. It has been highlighted in green for this photo. This indicates the air flow direction. The 2" hose will connect on the right side of this check valve in the next step.

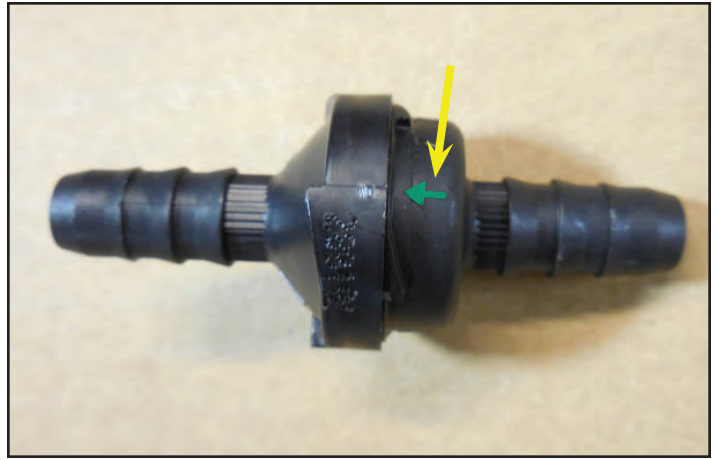

114. Ensure that the check valve is facing the direction shown in the last photo and attach the 2" hose on the right, and the 6.5" hose on the left.

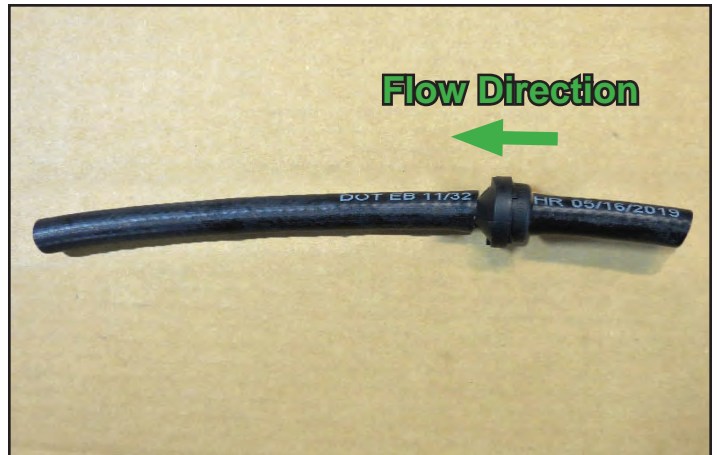

115. Place the mesh on either side of the hose. You can use tape to hold the mesh tighter to the hose if desired.



116. Install the provided quick connect fitting on the 6.5" long hose as shown.



117. Install the 2" hose section from the last step on the OEM brake booster assembly that you removed the section from earlier.

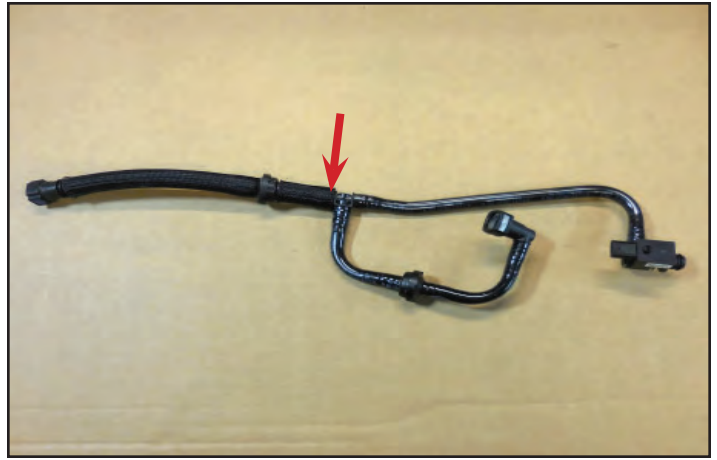

118. Apply a very small amount of Lubriplate grease to the OEM brake booster check valve barb.



119. Install the OEM brake booster check valve into its original location. Ensure that it is pressed in completely. Connect the electrical connection to the check valve.



120. Install the brake booster connection in the location shown with an arrow. Ensure that the lock engages and the connector is secure.

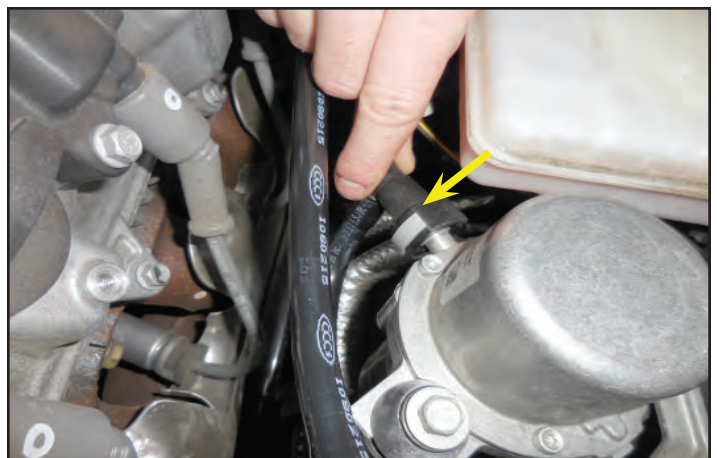

121. Install the final connection of the modified brake booster hose assembly at the inlet adaptor (yellow arrow location). Ensure that the lock engages and the connector is secure.

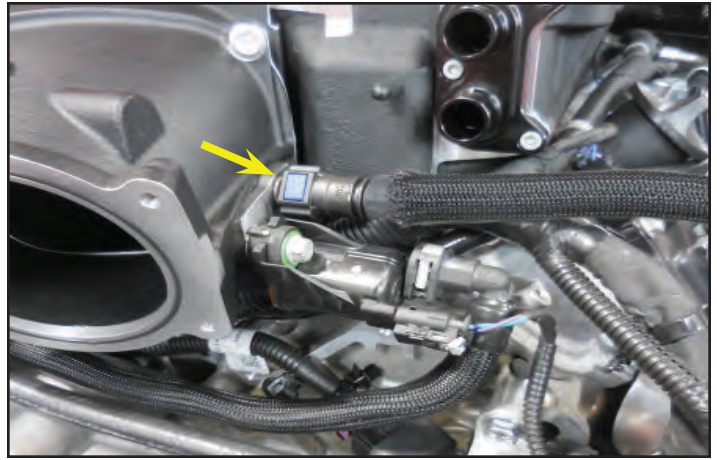

122. On the left side frame rail, just in front of the vacuum pump, remove the fastener at the ground wire shown with the yellow arrow. Also remove the fastener shown with the blue arrow. Use a 13 mm socket.



123. Move the ground wire from the yellow arrow location and combine it with the second ground wire at the blue arrow location. Reinstall the fastener and tighten.



124. Remove the cable tie fastener from the left side fender area just forward of the vacant grounding location. This location will be used for the mounting bracket.



125. Install the provided reservoir bracket in locations made from the previous steps with the two spacers provided (one shown with blue arrow) to gain clearance for the supercharger secondary belt drive. Use the provided M8x35mm hex flange bolt shown with the yellow arrow, and the provided M6x35mm flange bolt shown with the green arrow to secure the bracket. **Torque bolts to 106 in-lbs.** Take note of how the wire harness passes through the underside of the bracket.

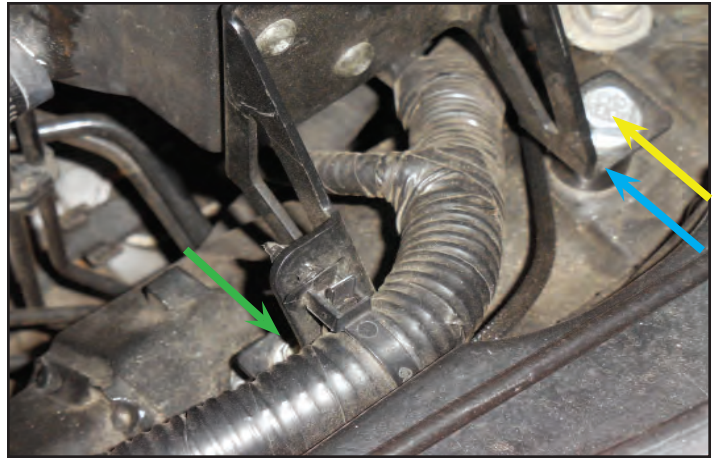

126. Install the reservoir to the bracket. The bolts (3 each) are shipped already attached to the reservoir. Tighten the bolts by hand most of the way prior to using a wrench. Install cable tie removed two steps ago into the location on the bracket shown with an arrow.



Section 6: Hose Line and Lid Installation

127. Install the hose assembly shown with the "Y" splitter in the location shown highlighted in green using three provided worm gear clamps. Attach the two upper sections of the hose to the lower spigots of the coolant manifolds. Install the lower portion of this hose where the "Y" is to the lower hose going to the front intercooler radiator. You will have to cut the hose coming from the intercooler radiator to fit.



128. Install the second hose assembly with the "Y" splitter shown highlighted in green with three provided worm gear clamps so that the two upper connections attach to the upper spigots on the coolant manifolds. Install the lower single connection to the back side of the intercooler reservoir using a provided worm gear clamp. **(Only use worm gear clamps at the reservoir for proper sealing.)**



129. Install the upper hose going to the intercooler pump (shown highlighted in green) to the lower connection on the intercooler reservoir using a provided worm gear clamp. You will have to cut this hose to fit.

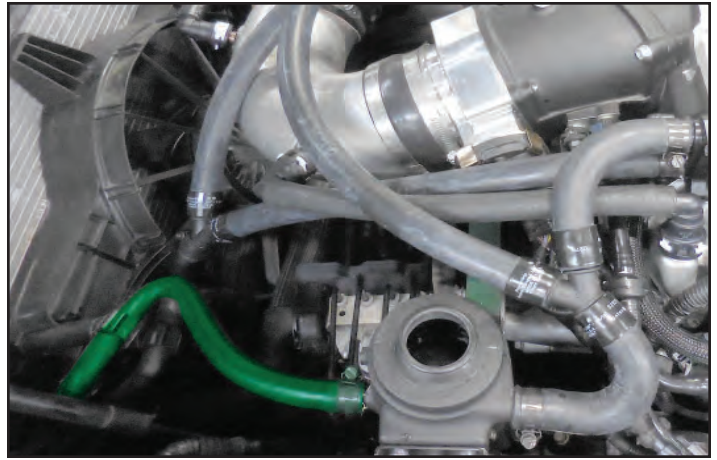

130. **Apply Loctite 242** to the 19 M6x20mm bolts that were removed from the lid and 4 more M6x30mm bolts that were provided and re-install the lid. The four M6x30mm bolts are for the center locations on the lid.



131. Lightly re-install the lid using the bolts from the last step.



132. **Torque these 23 bolts to 106in-lbs following the order for the lid given at the back of this manual.**



133. Gather the provided Magnuson Supercharged badges and M4x8mm bolts. Application of the adhesive backing from the two provided Magnuson Supercharged badges is optional.



134. Be aware that these badges will be difficult to remove once the adhesive has been applied. Install the badges using the provided bolts.



Section 7: EVAP, Throttle Body and Belt Installation

135. Reinstall the throttle body with the factory bolts (4 each). **Torque the throttle body bolts (4 each) to 106 in-lbs.** Also plug in the electrical connection at this time and ensure that you have engaged the lock.

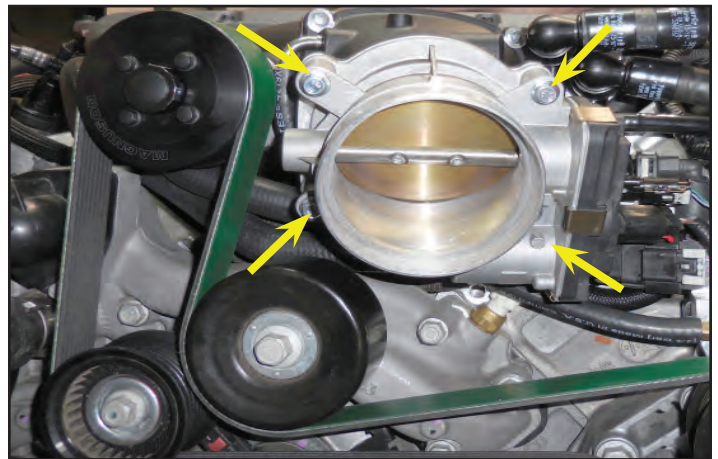

136. **Refer to the secondary belt routing diagram at the back of this manual.** Install the provided supercharger belt on all the pulleys except the 68mm smooth idler (blue arrow location). Then rotate the tensioner counter-clockwise (shown with a yellow arrow) using a 15mm socket and serpentine belt wrench. Then slip the belt under the 68mm smooth idler pulley. You may need help from someone for this step.



137. Install the OEM air duct between the throttle body and air box lid. Secure both sides of the air hose with the OEM hose clamps.



138. Gather the provided 5/8"x2"x1.5" 90° PCV elbow, 3/8"x5/8" reducer and 20" long x 5/16" ID PCV hose shown. Insert the 5/8" side of the reducer into the longer 2" side of the PCV elbow. Apply a light coat of Lubriplate grease on the 3/8" side of the reducer and insert it into the 5/16" hose.



139. Remove the OEM hose from the OEM vent hose assembly at the arrow location. Insert the 20" long x 5/16" ID hose from the last step at the arrow location as shown. Use a provided spring clamp to secure this location.



140. Reinstall the quick connect fitting from the hose assembly shown in the last step at the arrow location. Ensure that the lock engages and the connector is secure.



141. Make the next connection for the hose assembly, highlighted in green, at the center of the passenger side valve cover shown here with a yellow arrow. The red arrow connection will take place in the next step.

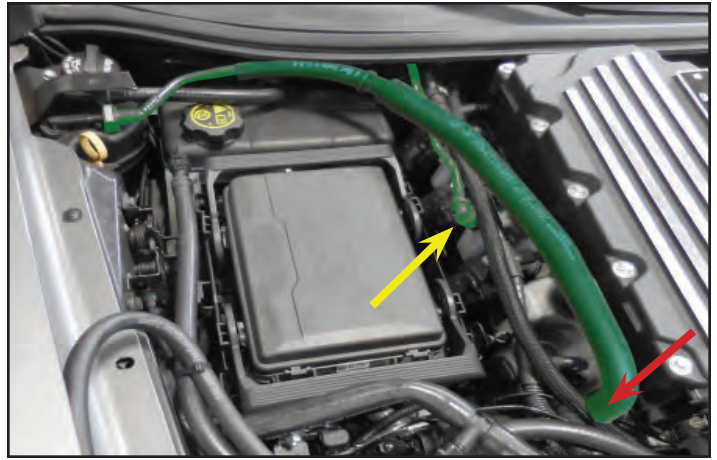

142. Slide the provided 28.6mm Oetiker clamp onto the 90° hose connection from the last step. Mount the hose connection on the passenger side valve cover air tube that was modified earlier. Slide the 28.6mm Oetiker clamp down to the end of the hose and secure with Oetiker clamp pliers as shown at the arrow.



143. Reinstall the PCV line shown with an arrow to the location on the air inlet hose. Ensure that the lock engages and the connector is secure.

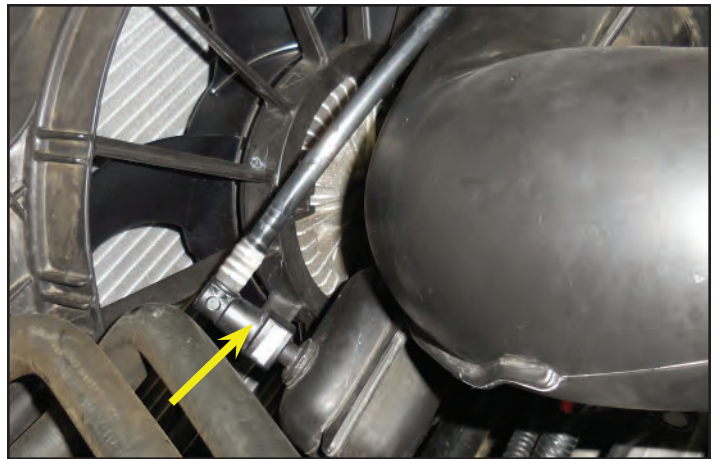

144. Reinstall the vent hose at the arrow location. Ensure that the lock engages and the connector is secure.



145. Remove the bypass solenoid from the OEM supercharger and connect it to the original electrical connection near the alternator (shown with a yellow arrow). Install the two provided rubber caps shown with the blue arrows. Secure the bypass solenoid with a provided cable tie (highlighted in green).

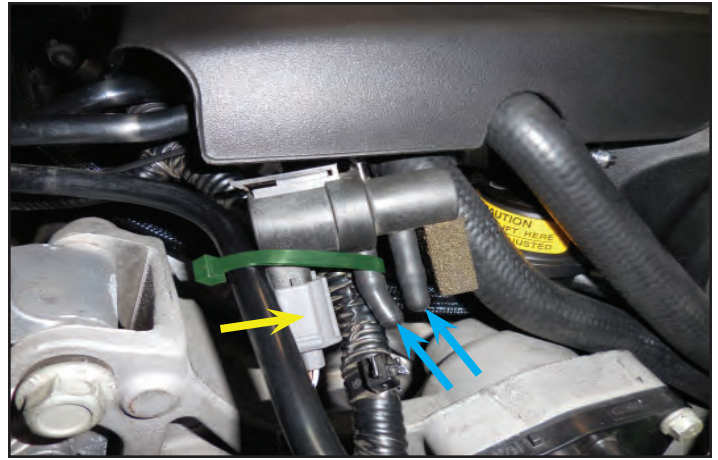

Section 8: Coolant Fill and Final Testing

*****WARNING: You must perform a vacuum leak down test on your intercooler system prior to adding any coolant. This can be accomplished with the same equipment that is used for engine cooling systems.*****

146. Remove the reservoir filler cap as shown here with the arrow.

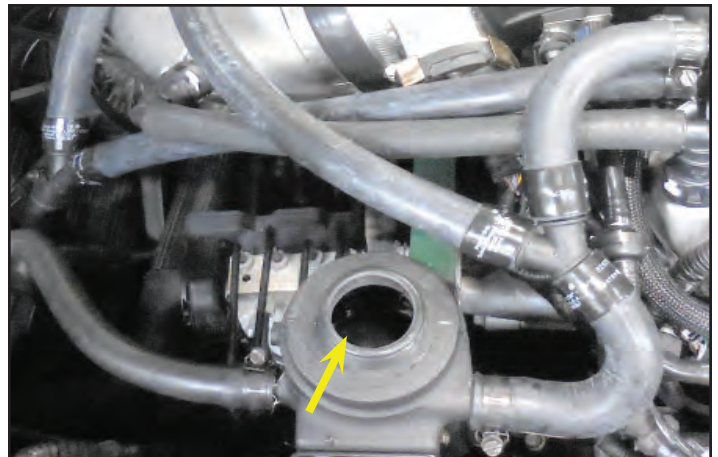

147. Place rags around the intercooler filler location. Use the GM approved engine coolant mixture to fill your intercooler reservoir to capacity. You may have to squeeze the hoses to release trapped air. Replace the cap once full. Clear tools and other items from engine area.

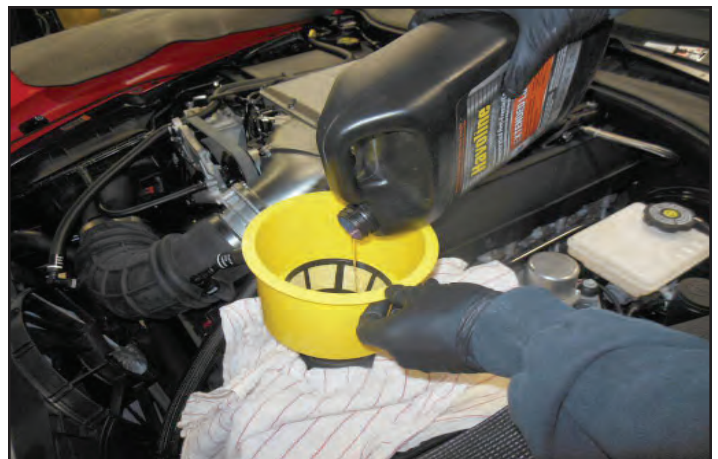

148. Connect the battery and tighten with 10 mm wrench.



Make sure that you have followed step #1 in this manual to load the proper supercharger calibration to your vehicle's ECM.



149. Have an assistant start the engine and let it idle for a few seconds to get the intercooler pump to start. Check for belt alignment at this time. Before the reservoir drains completely have your assistant turn the engine off. Do not let the reservoir run dry. Fill the reservoir some more and have your assistant cycle the engine again until you see the coolant level remains constant. While the pump is running check for circulation in the reservoir, and coolant leaks. Fill the reservoir to the base of the neck of the housing once all the air has been removed.



150. Depending on the pulley you are using you may need to remove some material from your extractor as shown here at the arrow location. Also due to manufacturing variances your hood liner may need to be removed as it might interfere with the surfaces on the supercharger.

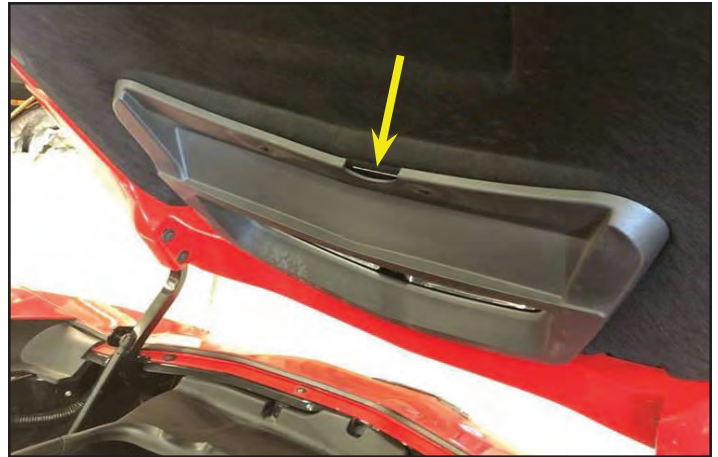

151. The supercharger is shown fully installed. Start the engine and check for coolant, and fuel leaks. Test drive vehicle for the first few miles under normal driving conditions. **Do not attempt any wide open throttle runs.** Check for any unusual sounds, vibrations, or engine misfires. The supercharger does have a slight whining noise under boost conditions, which is normal. After the initial test let the engine cool down, and recheck coolant levels.



152. After the initial test drive gradually work the vehicle to wide open throttle runs. Listen for any engine detonation (pinging). If engine detonation is detected let up on the throttle immediately. Most detonation is caused by low octane gasoline still in the tank. **Premium 91 octane fuel is required.** Affix the "Premium Fuel Only" sticker to the door of your gas fill cap. **After you finish your installation and road test your vehicle, please fill out the warranty registration. This can be found on our website.**



If you have questions about your vehicles performance, please check with your installation facility.

Appendix

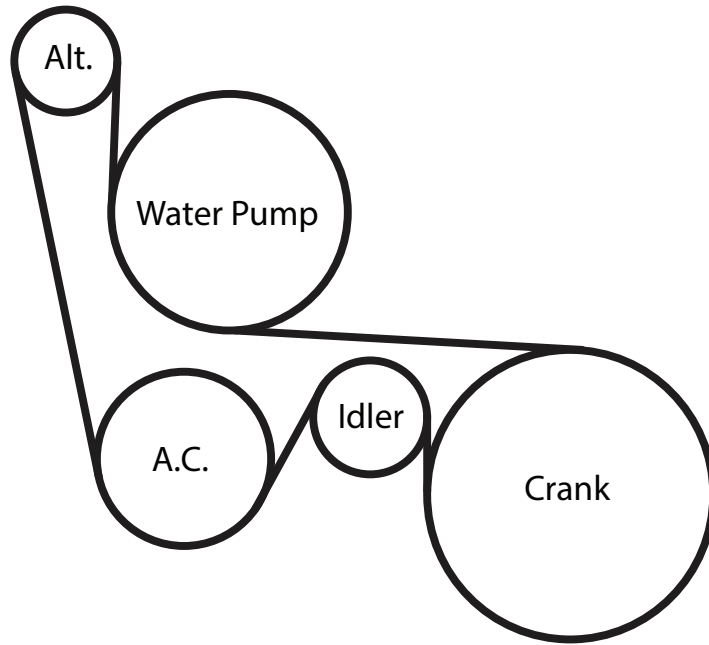

Primary Belt Diagram

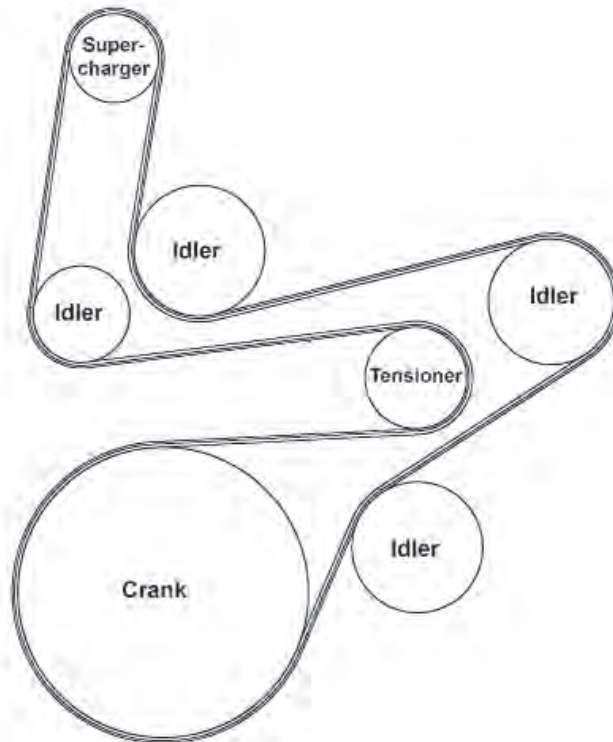

Secondary Belt Diagram

Torque Specifications

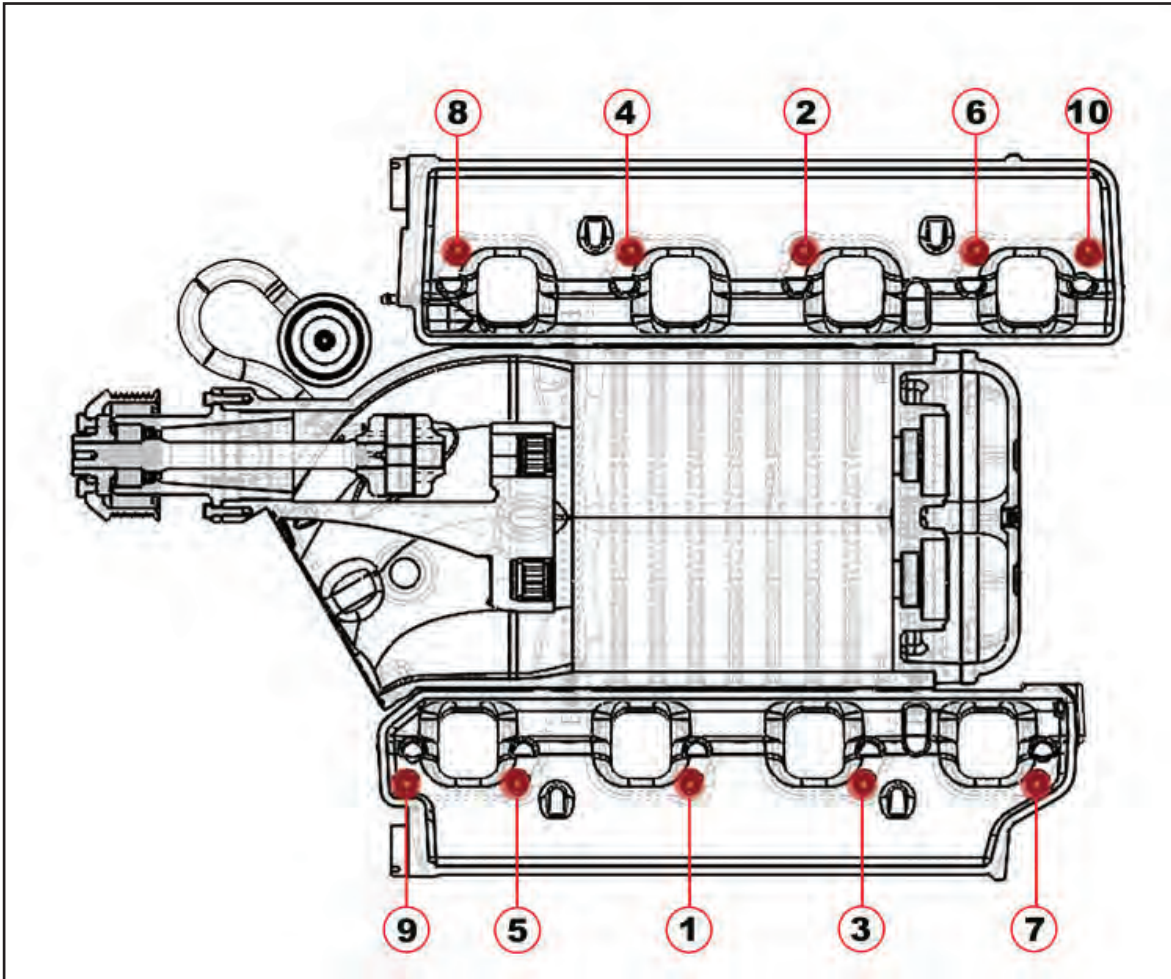

Supercharger to Cylinder Heads: 106in-lbs

Torque Specifications

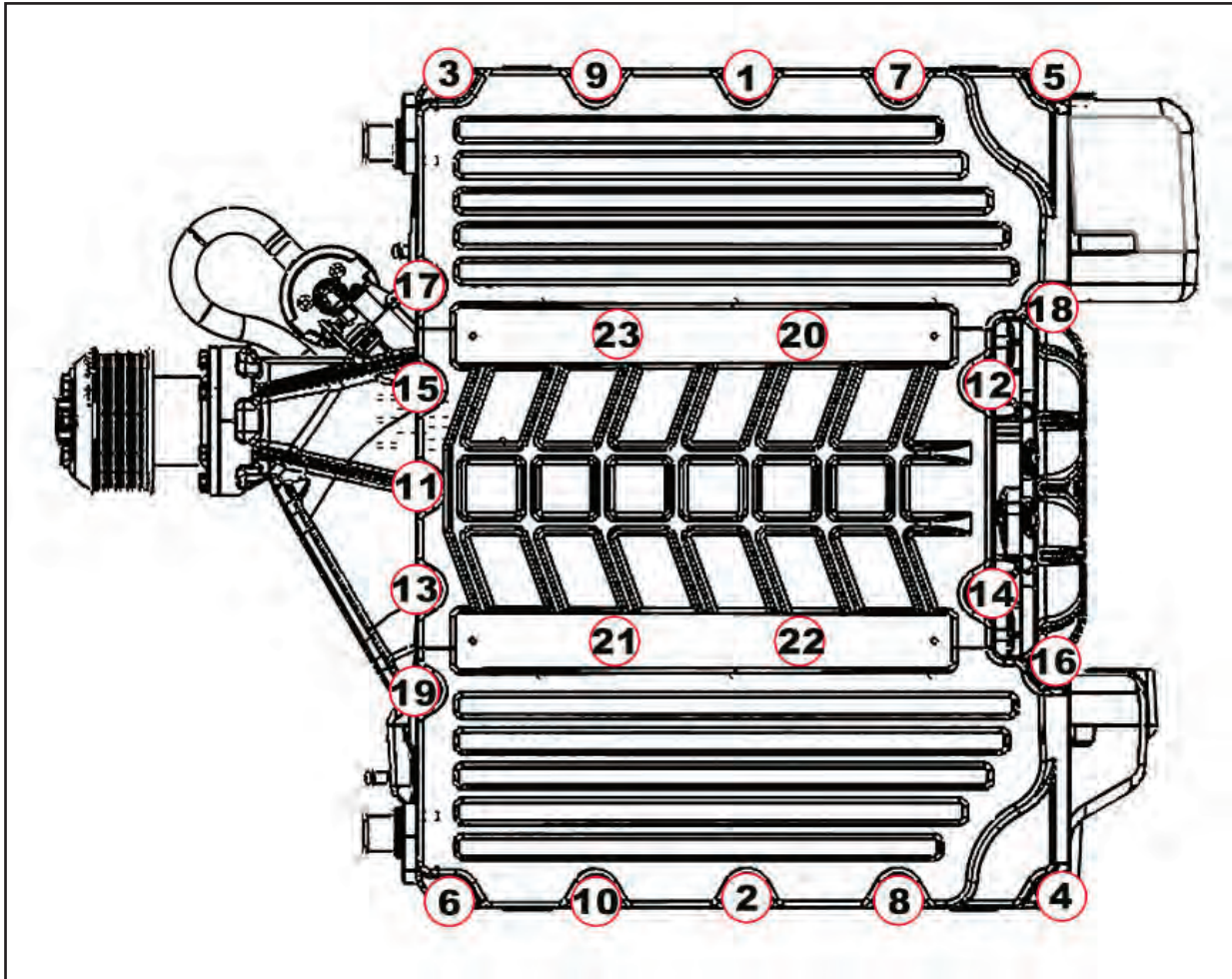

Lid to Supercharger Housing: 106in-lbs

Notes

Notes



Please enjoy your “Magnuson SuperCharged” performance responsibly.

Use only premium gasoline fuel, 91 octane or better.

MAGNUSON
SUPERCHARGERS